

LTM 1220NX-2

リープヘル製
オールテレーンクレーン

Technical Data

メインブーム
60m

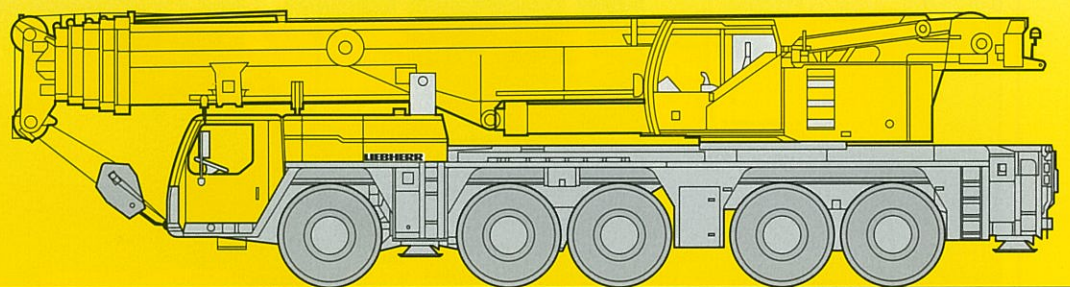

LIEBHERR

クレーン部主仕様

吊上荷重	荷重	242ton*
	半径	3m
メインブーム	最小長さ	13.3m
	最大長さ	60m
補助ジブ	油圧チルト式	12.2～36m
メインブーム伸縮段数		6段
カウンターウェイト (最大)		74ton
主巻ウインチ	ラインプル力	10.5ton
	巻上速度	0 - 130m/min
補巻ウインチ	ラインプル力	10.5ton
	巻上速度	0 - 130m/min
最大地上揚程	メインブーム	59m
	補助ジブ	102m
旋回速度		0 - 1.8rpm
起伏速度 (82度まで)		約50秒
ブーム伸長速度 (13.2～60m)		約360秒
主巻ロープ	ロープ径	23mm
	ロープ長さ	280m
補巻ロープ	ロープ径	23mm
	ロープ長さ	280m

*後方吊り

エンジン仕様

メーカー名	リープヘル社製
型式	D934LA6ディーゼル・エンジン
冷却方式	水冷
シリンダー数	4
出力	245HP/1800rpm
最大トルク	1140Nm/1500rpm
燃料タンク	約265 ℓ

特徴

■ コントロール

ジョイスティックタイプの操作レバー (自動復帰式のユニバーサルコントローラ) により電気式パイロットコントロールされます。

■ 油圧駆動装置

ウインチ回路には圧力補償付流量調整弁を有し、また、自動出力調整装置付油圧ポンプにより駆動されます。

■ 安全装置および指示計

LICCON (リーコン) 過負荷防止計が装備され、吊上げ総荷重、作業半径、ブーム長さ、揚程等がデジタルで表示されます。

過巻防止装置、ドラム回転計、過巻出し防止装置、油圧安全弁、油圧システム保護用安全バルブが装備されています。

キャビンが20度までチルトバックします。

*油圧チルトジブ使用時のメインブームエクステンション7mはオプション設定です。



キャリア部主仕様

軸数	5	
総輪数	10	
定員	2名	
最小回転半径	11.84/9.9m	
最高速度	①75km/h	②80km/h
登坂能力* (低速切換時)	①約31.7°	②約28.8°

*登坂時の路面状況により、能力も多少異なります。
 タイヤ ①14.00R25 ②16.00R25 (オプション設定)

エンジン仕様

メーカー名	リープヘル社製
型式	D846A7ディーゼル・エンジン
冷却方式	水冷
シリンダー数	6
出力	503HP/1500rpm
最大トルク	2355Nm/1200-1500rpm
燃料タンク	約490ℓ

特徴

■ トランスミッション

ZF製16段ギアボックス付ミッションで“AS-TRONIC”自動制御システムを採用しています。

■ 車軸

悪路においては、デフロックすることが可能で第2軸も追加駆動することができます。(第2軸駆動はオプション)

■ サスペンション

全輪ハイドロニューマチックサスペンションであり、自動水平復帰機能(ニポー)を有しています。

状況に応じて車高を上下に調整可能です。

全輪油圧サスペンションをロックすることが可能です。

■ ステアリング

全ての軸が操舵されます。油圧源として1つは通常時、エンジンで駆動され、もう1つは非常用として駆動軸により駆動されます。

■ 常用ブレーキ

2回路式サーボブレーキが全軸に装備されています。

また、エディカレント式電磁ブレーキ(オプション)を装備しています。

■ パーキング用ブレーキ

スプリング作動のブレーキが第2軸および5軸に作動します。

走行速度

タイヤ	🚧	1	2	3	4	5	6	7	8	9	10	11	12	R1	R2	🚚
14.00R25	🚧 (km/h)	5.2	6.7	8.6	11.1	14	18.1	23.8	30.6	39.4	50.5	64.2	75	5.6	7.2	48%
		2.3	2.9	3.8	4.8	6.1	7.9	10.4	13.3	17.2	22	28	35.8	2.4	3.1	>60%
16.00R25	🚧 (km/h)	5.7	7.3	9.4	12.1	15.3	19.7	25.9	33.2	42.8	55	69.8	80	6.1	7.9	43%
		2.5	3.2	4.1	5.3	6.7	8.6	11.3	14.5	18.7	23.9	30.4	39	2.7	3.4	56%



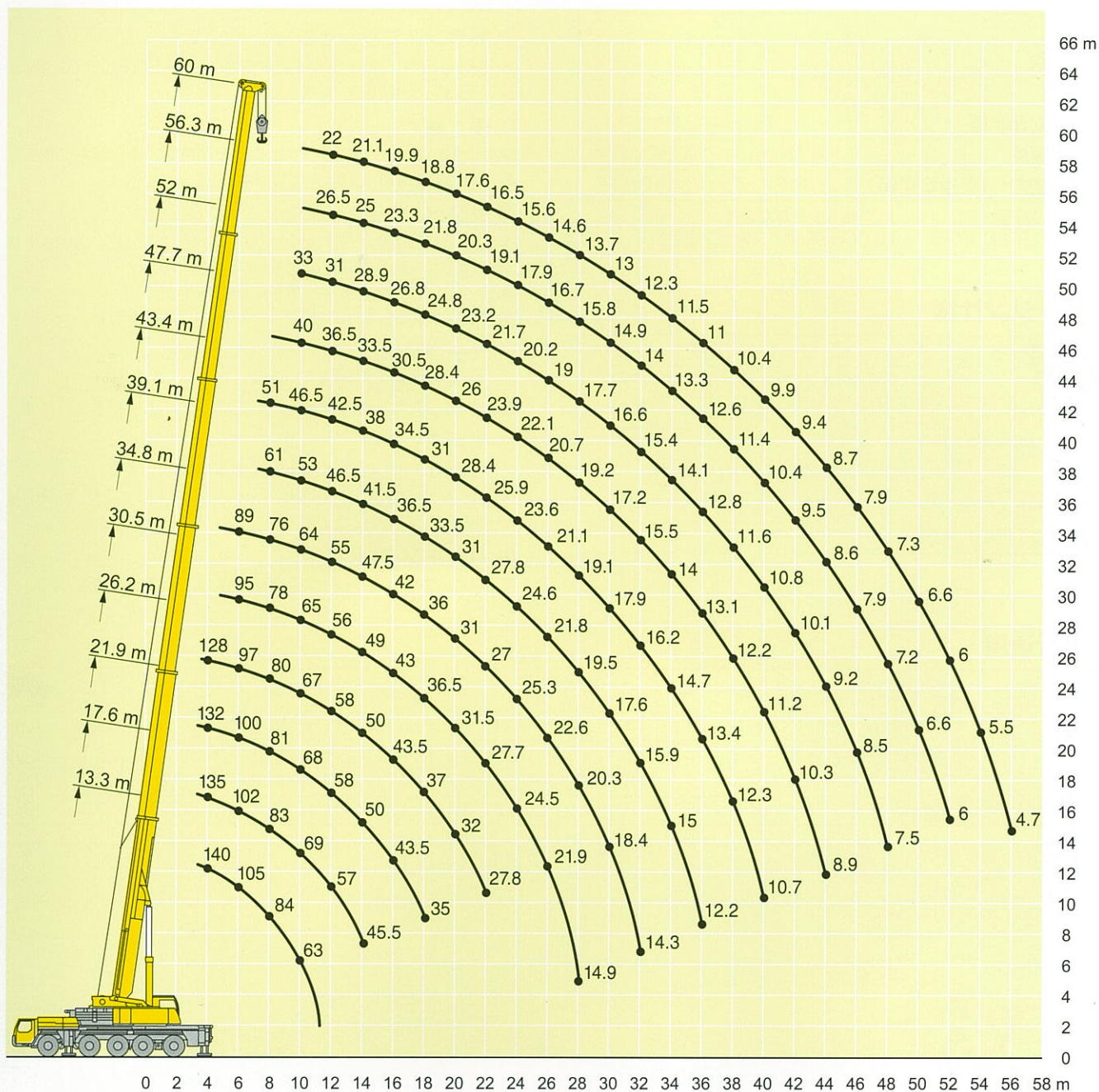

注意

- 1 定格総荷重はフックブロック、玉掛ワイヤー等の自重を含みます。
また、下記の条件が考慮されていませんのでクレーンの操作には充分気をつけてください。
 - ① 地盤の強度、地震による影響
 - ② 作業速度に応じた動荷重および台風または強風による影響等
- 2 本機は水平に設置して、クレーン作業を行ってください。
- 3 作業半径は、クレーンの旋回中心から荷重の重心までの水平距離です。
- 4 メインブームの定格総荷重は油圧チルトジブを取り除いた状態の値です。
- 5 135/152トンを超える定格総荷重の場合は、追加ブーリーブロック/特殊吊装置が必要です。

メインブーム定格総荷重表

LTM 1220NX-2



13.3m-60m

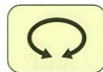

360°



74t

作業半径(m)	メインブーム長さ		17.6m	21.9m	26.2m	30.5m	34.8m	39.1m	43.4m	47.7m	52m	56.3m	60m		
	*	13.3m													
3		242	152	140	139										
3.5		152	152	140	139	139									
4		140	140	135	132	128									
4.5		127	127	123	120	118	113								
5		119	119	116	113	110	106								
6		105	105	102	100	97	95	89							
7		94	94	92	89	87	86	83	64						
8		84	84	83	81	80	78	76	61	51					
9		74	74	76	74	73	71	69	57	49	41				
10		63	63	69	68	67	65	64	53	46.5	40	33			
11		45.5	45.5	63	63	62	61	59	50	44.5	38	32	27.1		
12				57	58	58	56	55	46.5	42.5	36.5	31	26.5	22	
14				45.5	50	50	49	47.5	41.5	38	33.5	28.9	25	21.1	
16					43.5	43.5	43	42	36.5	34.5	30.5	26.8	23.3	19.9	
18						35	37	36.5	36	33.5	31	28.4	24.8	21.8	18.8
20							32	31.5	31	31	28.4	26	23.2	20.3	17.6
22							27.8	27	27	27.8	25.9	23.9	21.7	19.1	16.5
24							15.7	24.5	25.3	24.6	23.6	22.1	20.2	17.9	15.6
26								21.9	22.6	21.8	21.1	20.7	19	16.7	14.6
28								14.9	20.3	19.5	19.1	19.2	17.7	15.8	13.7
30									18.4	17.6	17.9	17.2	16.6	14.9	13
32									14.3	15.9	16.2	15.5	15.4	14	12.3
34										15	14.7	14	14.1	13.3	11.5
36										12.2	13.4	13.1	12.8	12.6	11
38											12.3	12.2	11.6	11.4	10.4
40											10.7	11.2	10.8	10.4	9.9
42												10.3	10.1	9.5	9.4
44												8.9	9.2	8.6	8.7
46													8.5	7.9	7.9
48													7.5	7.2	7.3
50														6.6	6.6
52														6	6
54															5.5
56															4.7
ブーム伸率 (%)	I	0		0/0/0	0/0/0	46/0/0	46/0/0	46/0/0	92/46/0	92/46/0	92/92/46	92/92/46	92	100	
	II	0		0/0/0	46/0/0	46/46/0	46/46/0	46/46/0	46/46/46	46/46/46	92/46/46	92/46/92	92	100	
	III	0		46/0/0	46/46/0	46/46/46	46/46/92	46/46/46	46/46/46	46/46/92	46/46/92	46/92/92	92	100	
	IV	0		0/46/0	0/46/46	0/46/46	46/46/46	46/46/92	46/46/92	46/92/92	46/92/92	92/92/92	92	100	
	V	0		0/0/46	0/0/46	0/0/46	0/46/46	46/92/92	46/92/92	92/92/92	92/92/92	92/92/92	92	100	

*後方吊り

TAB 151259/151363



13.3m-60m

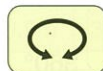

360°



54t

作業半径(m)	メインブーム長さ		17.6m	21.9m	26.2m	30.5m	34.8m	39.1m	43.4m	47.7m	52m	56.3m	60m	
	*	13.3m												
3		152	140	139										
3.5		152	140	139	139									
4		140	135	132	128									
4.5		127	123	120	118	113								
5		119	116	113	110	106								
6		105	102	100	97	95	89							
7		94	92	89	87	86	83	64						
8		84	83	81	80	78	76	61	51					
9		74	76	74	73	71	69	57	49	41				
10		63	68	68	67	64	60	53	46.5	40	33			
11		45.5	60	61	60	57	53	50	44.5	38	32	27.1		
12			54	54	53	51	48	45.5	42.5	36.5	31	26.5	22	
14			43	43.5	43.5	41.5	39.5	39.5	37.5	33.5	28.9	25	21.1	
16				36.5	36.5	35	34.5	33	31.5	30.5	26.8	23.3	19.9	
18				31	31	30	30	28.5	26.9	26.8	24.8	21.8	18.8	
20					26.5	26	26.4	24.8	24.7	23.3	22.7	20.3	17.6	
22					23.1	22.5	23.3	21.8	21.8	20.5	20.2	19.1	16.5	
24					15.7	20.1	20.5	20.3	19.3	18.8	17.9	17.3	15.6	
26						17.8	18.2	18.4	17.3	16.9	16.4	15.4	14.6	
28						14.9	16.2	16.5	15.5	15.2	14.7	13.7	13.7	
30							15.1	14.8	14.5	13.7	13.3	12.3	12.3	
32							13.9	13.3	13.3	12.7	12	11.1	11	
34								12.1	12	11.6	10.9	10	9.9	
36								11	10.8	10.4	9.9	9	9	
38									9.8	9.4	8.9	8.1	8.1	
40									9	8.5	8	7.3	7.3	
42										7.7	7.2	6.6	6.6	
44										7	6.5	5.8	5.9	
46											5.8	5.2	5.3	
48											5.3	4.6	4.7	
50												4.1	4.1	
52												3.6	3.6	
54													3.2	
56													2.8	
ブーム伸率 (%)	I	0		0/0/0	0/0/0	46/0/0	46/0/0	46/0/0	92/46/0	92/46/0	92/46/0	92/92/46	92	100
	II	0		0/0/0	46/0/0	46/46/0	46/46/0	46/46/0	46/46/46	46/46/46	92/46/92	92/46/92	92	100
	III	0		46/0/0	46/46/0	46/46/46	46/46/92	46/46/46	46/46/46	46/92/92	46/92/92	46/92/92	92	100
	IV	0		0/46/0	0/46/46	0/46/46	46/46/46	46/46/92	46/46/92	46/92/92	46/92/92	92/92/92	92	100
	V	0		0/0/46	0/0/46	0/0/46	0/46/46	46/92/92	46/92/92	92/92/92	92/92/92	92/92/92	92	100

TAB 151264

メインブーム定格総荷重表

LTM 1220NX-2



13.3m-60m



360°



44t

メインブーム 長さ	13.3m	17.6m	21.9m	26.2m	30.5m	34.8m	39.1m	43.4m	47.7m	52m	56.3m	60m	
3	152	140	139										
3.5	152	140	139	139									
4	140	135	132	128									
4.5	127	123	120	118	113								
5	119	116	113	110	106								
6	105	102	100	97	95	89							
7	94	92	89	87	86	83	64						
8	83	83	81	80	75	70	61	51					
9	72	73	71	68	64	60	57	49	41				
10	61	63	62	59	56	53	50	46.5	40	33			
11	45.5	55	55	52	49.5	46.5	45.5	43.5	38	32	27.1		
12		48.5	49	46.5	44.5	42	41.5	39.5	36.5	31	26.5	22	
14		39	39.5	38	36	36.5	34	32.5	31.5	28.9	25	21.1	
16			32.5	32	30.5	30.5	28.7	28.5	26.9	26.1	23.3	19.9	
18			27.3	27.3	26.4	26.2	25.5	24.5	23.5	22.7	21.8	18.8	
20				23.5	22.8	22.7	22.5	21.3	20.7	20.1	19	17.6	
22				20.9	19.9	20	19.8	19.2	18.5	17.6	16.5	16.4	
24				15.7	17.3	18.5	17.6	17.2	16.4	15.6	14.5	14.4	
26					15.5	16.3	15.7	15.3	14.6	13.8	12.8	12.8	
28					14.5	14.5	14.2	13.7	13	12.3	11.3	11.3	
30						13	12.8	12.4	11.7	11	10.1	10.1	
32						11.7	11.4	11.2	10.6	9.8	9	8.9	
34							10.2	10	9.5	8.8	8	8	
36							9.2	8.9	8.5	8	7.1	7.1	
38								8	7.6	7.1	6.3	6.3	
40								7.3	6.8	6.3	5.6	5.6	
42									6.1	5.6	4.9	5	
44									5.4	4.9	4.3	4.4	
46										4.3	3.7	3.8	
48										3.8	3.2	3.2	
50											2.7	2.7	
52											2.2	2.3	
54												1.9	
56												1.5	
ブーム 伸長率 (%)	I	0	0/0/0	0/0/0	46/0/0	46/0/0	46/0/0	92/46/0	92/46/0	92/92/0	92/92/46	92	100
	II	0	0/0/0	46/0/0	46/46/0	46/46/0	46/46/0	46/46/46	46/46/46	92/46/92	92/46/92	92	100
	III	0	46/0/0	46/46/0	46/46/46	46/46/92	46/46/46	46/46/46	46/46/92	46/46/92	46/92/92	92	100
	IV	0	0/46/0	0/46/46	0/46/46	46/46/46	46/46/92	46/46/92	46/92/92	46/92/92	92/92/92	92	100
	V	0	0/0/46	0/0/46	0/0/46	0/46/46	46/92/92	46/92/92	92/92/92	92/92/92	92/92/92	92	100

TAB 151265



13.3m-60m



360°



34t

メインブーム 長さ	13.3m	17.6m	21.9m	26.2m	30.5m	34.8m	39.1m	43.4m	47.7m	52m	56.3m	60m	
3	152	140	139										
3.5	152	140	139	139									
4	140	135	132	128									
4.5	127	123	120	118	113								
5	119	116	113	110	106								
6	105	102	100	97	95	87							
7	92	92	87	83	77	72	64						
8	78	76	73	69	65	60	57	51					
9	65	65	62	59	55	52	51	48	41				
10	55	56	54	51	48.5	46.5	44.5	42	40	33			
11	45.5	49	47	45	42.5	42.5	39.5	37.5	36	32	27.1		
12		43	42	40	38	38	35.5	34.5	33	31	26.5	22	
14		34	34	32.5	31.5	31	30.5	28.8	27.8	26.5	25	21.1	
16			28.2	28.2	26.2	26.1	25.6	24.9	23.9	22.7	21.4	19.9	
18			23.4	24.2	22.2	23	21.9	21.3	20.4	19.4	18.2	18	
20				20.5	19.7	20	19.2	18.5	17.6	16.7	15.6	15.4	
22				17.7	17.8	17.5	16.8	16.1	15.3	14.4	13.4	13.3	
24				15.5	15.5	15.5	14.8	14.1	13.4	12.6	11.6	11.5	
26					13.6	13.6	13.1	12.5	11.8	11	10	10	
28					12	12	11.7	11.1	10.4	9.7	8.7	8.7	
30						10.6	10.3	9.9	9.2	8.5	7.6	7.6	
32						9.4	9.1	8.8	8.2	7.5	6.6	6.6	
34							8	7.8	7.3	6.6	5.7	5.8	
36							7.2	6.9	6.4	5.8	5	5	
38								6.1	5.6	5.1	4.3	4.3	
40								5.4	4.9	4.4	3.7	3.7	
42									4.3	3.8	3.1	3.2	
44									3.7	3.2	2.6	2.7	
46										2.7	2.1	2.2	
48										2.3	1.6	1.7	
50											1.2	1.3	
ブーム 伸長率 (%)	I	0	0/0/0	0/0/0	0/0/0	0/0/0	46/0/0	46/0/0	92/46/0	92/46/0	92/92/46	92	100
	II	0	0/0/0	46/0/0	46/0/0	46/0/0	46/46/0	46/46/0	46/46/46	92/46/92	92/46/92	92	100
	III	0	46/0/0	46/46/0	46/46/0	46/92/0	46/46/46	46/46/92	46/46/92	46/92/92	46/92/92	92	100
	IV	0	0/46/0	0/46/46	46/46/46	46/46/92	46/46/92	46/92/92	46/92/92	46/92/92	92/92/92	92	100
	V	0	0/0/46	0/0/46	0/46/92	46/46/92	46/92/92	92/92/92	92/92/92	92/92/92	92/92/92	92	100

TAB 151267

メインブーム定格総荷重表

LTM 1220NX-2



13.3m-60m



360°



32t

メインブーム長さ 作業半径(m)	13.3m	17.6m	21.9m	26.2m	30.5m	34.8m	39.1m	43.4m	47.7m	52m	56.3m	60m	
3	152	140	139										
3.5	152	140	139	139									
4	140	135	132	128									
4.5	127	123	120	118	113								
5	119	116	113	110	106								
6	105	102	100	97	92	85							
7	91	90	84	80	75	69	64						
8	76	74	71	67	63	58	55	51					
9	63	63	60	57	54	51	49.5	46.5	41				
10	54	54	52	49.5	47	46	43.5	40.5	39	33			
11	45.5	47.5	45.5	43.5	41	41	38.5	36	35.5	32	27.1		
12		42	40.5	38.5	37.5	36.5	34.5	34	32	30.5	26.5	22	
14		32.5	33	31.5	30.5	29.9	29.4	27.8	26.9	26	24.5	21.1	
16			27.3	27.4	25.2	26	24.7	24	23	21.9	20.6	19.9	
18			22.6	23.4	21.7	22.2	21.4	20.5	19.7	18.6	17.4	17.2	
20				19.8	19.7	19.3	18.5	17.7	16.9	15.9	14.8	14.7	
22				17.1	17.2	16.8	16.1	15.4	14.6	13.8	12.7	12.6	
24				14.9	14.9	14.8	14.1	13.5	12.7	11.9	10.9	10.9	
26					13	13.1	12.5	11.9	11.2	10.4	9.5	9.4	
28					11.4	11.4	11.1	10.5	9.8	9.1	8.2	8.2	
30						10.1	9.8	9.3	8.7	8	7.1	7.1	
32						8.9	8.6	8.3	7.7	7	6.1	6.2	
34							7.6	7.3	6.8	6.2	5.3	5.3	
36							6.7	6.4	6	5.4	4.6	4.6	
38								5.7	5.2	4.7	3.9	3.9	
40								5	4.5	4.1	3.3	3.3	
42									3.9	3.4	2.8	2.8	
44									3.4	2.9	2.2	2.3	
46										2.4	1.7	1.8	
48										2	1.3	1.4	
ブーム伸長率 (%)	I	0	0/0/0	0/0/0	46/0/0	46/0/0	46/0/0	92/46/0	92/46/0	92/46/0	92/92/46	92	100
	II	0	0/0/0	46/0/0	46/46/0	46/46/0	46/46/0	46/46/0	46/46/46	92/46/92	92/46/92	92	100
	III	0	46/0/0	46/46/0	46/46/46	46/46/92	46/46/46	46/46/92	46/46/92	46/92/92	46/92/92	92	100
	IV	0	0/46/0	0/46/46	0/46/46	46/46/46	46/46/92	46/46/92	46/92/92	46/92/92	46/92/92	92	100
	V	0	0/0/46	0/0/46	0/0/46	0/46/46	46/92/92	46/92/92	92/92/92	92/92/92	92/92/92	92	100

TAB 151268



13.3m-60m



360°



22t

メインブーム長さ 作業半径(m)	13.3m	17.6m	21.9m	26.2m	30.5m	34.8m	39.1m	43.4m	47.7m	52m	56.3m	60m	
3	152	140	139										
3.5	152	140	139	139									
4	140	135	132	128									
4.5	127	123	120	118	113								
5	119	116	113	108	100								
6	102	98	90	85	78	71							
7	82	76	73	68	63	59	57						
8	66	63	60	56	53	52	48	44.5					
9	55	53	51	48	45.5	44.5	41.5	40	37.5				
10	46	45	43.5	41.5	39.5	38.5	37.5	35.5	33.5	31.5			
11	39	39.5	38	38	35	34	33.5	31.5	30.5	28.9	27		
12		34.5	34	33.5	31	31.5	29.8	28.7	27.3	25.8	24.1	22	
14		27	27.3	27.1	26.3	25.5	24.4	23.3	22.1	20.9	19.4	19.1	
16			22.4	22.3	21.7	21.1	20.2	19.3	18.3	17.2	15.9	15.8	
18			18.2	18.7	18.2	17.7	17	16.2	15.3	14.4	13.2	13.1	
20				15.9	15.6	15.1	14.5	13.8	13	12.1	11.1	11	
22				13.5	13.4	13.1	12.4	11.8	11.1	10.3	9.3	9.3	
24				11.6	11.6	11.4	10.8	10.2	9.5	8.8	7.8	7.8	
26					9.9	10	9.4	8.8	8.2	7.5	6.6	6.6	
28					8.6	8.6	8.2	7.7	7.1	6.4	5.5	5.5	
30						7.5	7.2	6.7	6.1	5.4	4.6	4.6	
32						6.5	6.2	5.9	5.3	4.6	3.8	3.8	
34							5.3	5.1	4.5	3.9	3.1	3.1	
36							4.6	4.3	3.9	3.3	2.4	2.5	
38								3.7	3.2	2.7	1.9	1.9	
40								3.1	2.6	2.2	1.4	1.4	
42									2.1	1.7			
44									1.7	1.2			
ブーム伸長率 (%)	I	0	0/0/0	0/0/0	0/0/0	0/0/0	46/0/0	46/0/0	92/46/0	46/46/0	92/92/46	92	100
	II	0	0/0/0	46/0/0	46/0/0	46/0/0	46/46/0	46/46/0	46/46/46	92/46/92	92/46/92	92	100
	III	0	46/0/0	46/46/0	46/46/0	46/92/0	46/46/46	46/46/92	46/46/92	46/92/92	46/92/92	92	100
	IV	0	0/46/0	0/46/46	46/46/46	46/46/92	46/46/92	46/92/92	46/92/92	46/92/92	46/92/92	92	100
	V	0	0/0/46	0/0/46	0/46/92	46/46/92	46/92/92	92/92/92	92/92/92	46/92/92	92/92/92	92	100

TAB 151269

メインブーム定格総荷重表

LTM 1220NX-2



13.3m-60m



360°



12t

メインブーム長さ 作業半径(m)	13.3m	17.6m	21.9m	26.2m	30.5m	34.8m	39.1m	43.4m	47.7m	52m	56.3m	60m	
3	151	135	135										
3.5	138	135	135	126									
4	128	127	126	110									
4.5	117	117	109	95	87								
5	107	103	92	84	76								
6	83	76	71	65	59	55							
7	64	61	57	53	49	47	43						
8	51	49.5	47	43.5	41	39.5	38	35					
9	40	41.5	39.5	38.5	35	35	32.5	30.5	28.8				
10	32.5	35	34	33	31.5	30	28.4	26.7	25.1	23.4			
11	27.1	29.1	29.4	28.8	27.6	26.4	25	23.5	22.1	20.6	18.9		
12		24.6	25.7	25.3	24.4	23.4	22.1	20.9	19.6	18.2	16.7	16.3	
14		18.2	19.3	20.1	19.4	18.7	17.7	16.7	15.7	14.6	13.2	13	
16			15	15.8	15.9	15.3	14.5	13.7	12.8	11.8	10.6	10.5	
18			12	12.7	12.9	12.7	12	11.3	10.5	9.6	8.5	8.5	
20				10.5	10.6	10.7	10.1	9.4	8.7	7.9	6.9	6.8	
22					8.7	8.8	8.9	8.5	7.9	7.2	6.5	5.5	
24				7.3	7.4	7.4	7.2	6.6	6	5.3	4.4	4.4	
26					6.1	6.2	6	5.6	5	4.3	3.4	3.4	
28					5.2	5.2	5	4.7	4.1	3.4	2.6	2.6	
30						4.4	4.1	3.9	3.3	2.7	1.9	1.9	
32						3.7	3.4	3.1	2.7	2.1			
34							2.8	2.5	2.1				
36							2.2	2	1.6				
38								1.5					
40								1.1					
ブーム伸長率 (%)	I	0	0/0/0	46/0/0	46/0/0	0/0/0	0/0	0/0/0	46/0	0	46	92	100
	II	0	46/0/0	46/0/0	46/0/0	46/0/0	46/0	46/46/0	46/46	92	92	92	100
	III	0	0/0/0	0/0/0	46/46/0	46/92/0	46/46	92/46/92	46/92	92	92	92	100
	IV	0	0/46/0	0/46/0	0/46/46	46/46/92	46/92	92/92/92	92/92	92	92	92	100
	V	0	0/0/46	0/46/92	0/46/92	46/46/92	92/92	46/92/92	92/92	92	92	92	100

TAB 151361



13.3m-60m



360°



0t

メインブーム長さ 作業半径(m)	13.3m	17.6m	21.9m	26.2m	30.5m	34.8m	39.1m	43.4m	47.7m	52m	56.3m	60m	
3	150	135	135										
3.5	137	135	123	105									
4	125	115	99	88									
4.5	107	93	83	73	65								
5	86	78	70	63	57								
6	61	57	53	50	44	42							
7	45.5	43	41	39	36	33.5	31						
8	34.5	34	32.5	31.5	29.6	27.8	25.8	23.9					
9	27.4	27.4	26.8	26.1	24.8	23.4	21.8	20.3	18.7				
10	21.4	22.6	22.4	22	21.1	20	18.7	17.4	16.1	14.7			
11	17.1	19	19	18.9	18.1	17.3	16.2	15	13.9	12.6	11.2		
12		15.9	16.3	16.4	15.8	15.1	14.1	13.1	12.1	10.9	9.6	9.4	
14		11.3	12.4	12.6	12.2	11.7	10.9	10.1	9.2	8.3	7.1	7	
16			9.3	9.9	9.6	9.2	8.6	7.9	7.1	6.3	5.2	5.1	
18			6.9	7.8	7.6	7.3	6.8	6.2	5.5	4.7	3.7	3.7	
20				6	6.1	5.9	5.3	4.8	4.2	3.4	2.5		
22				4.7	4.8	4.7	4.2	3.7	3.1	2.4			
24				3.7	3.7	3.7	3.3	2.8					
26					2.8	2.9	2.5						
28					2.1	2.1							
ブーム伸長率 (%)	I	0	0/0/0	46/0/0	0/0/0	0/0/0	0/0/0	0/0/0	92/46/0	46/46/0	92/92/46	92	100
	II	0	46/0/0	46/0/0	46/0/0	46/0/0	46/0/0	46/46/0	46/46/46	92/46/92	92/46/92	92	100
	III	0	0/0/0	0/0/0	46/46/0	46/92/0	46/92/46	92/46/92	46/46/92	92/92/92	46/92/92	92	100
	IV	0	0/46/0	0/46/0	46/46/46	46/46/92	46/92/92	92/92/92	46/92/92	92/92/92	92/92/92	92	100
	V	0	0/0/46	0/46/92	0/46/92	46/46/92	92/46/92	46/92/92	92/92/92	46/92/92	92/92/92	92	100

TAB 151362

ジブ長さ 12.2m、22m

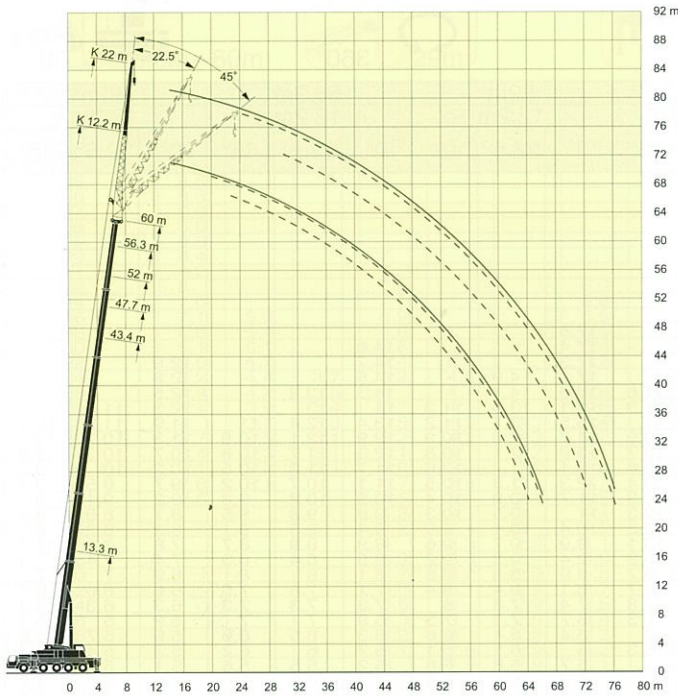

ジブ長さ 29m

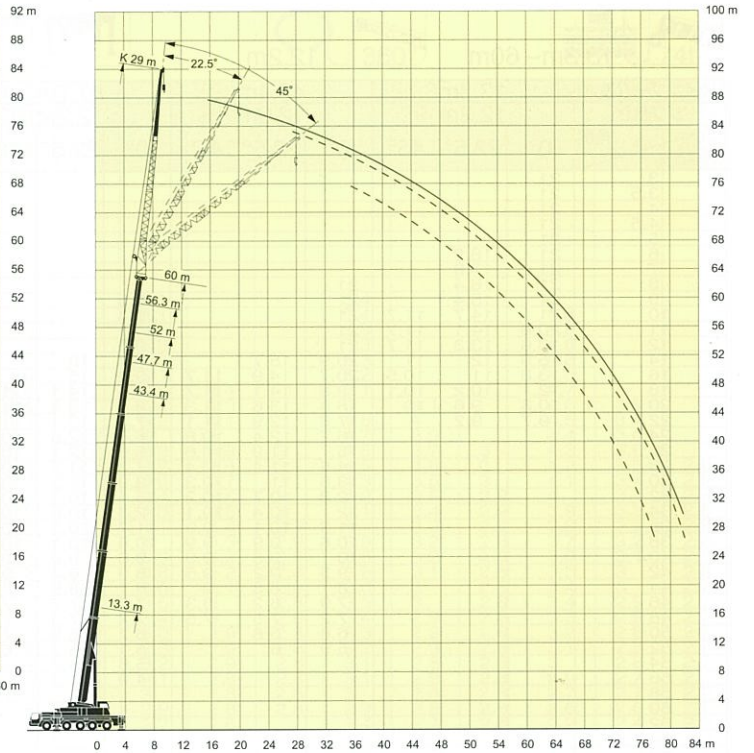

ジブ長さ 36m

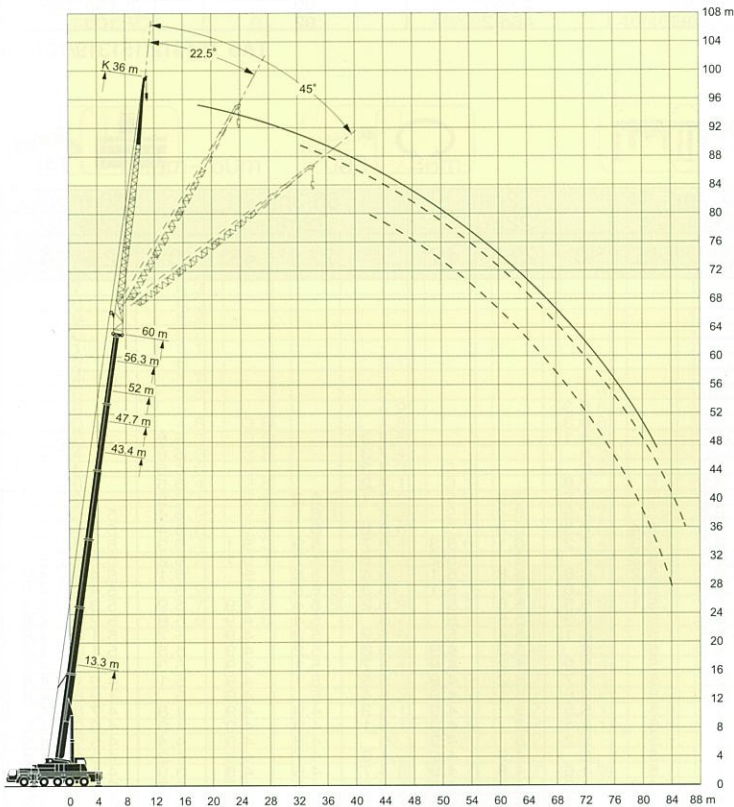

注意

- 1 定格総荷重はフックブロック、玉掛ワイヤー等の自重を含みます。
また、下記の条件が考慮されていないのでクレーンの操作には充分気をつけてください。
 - ① 地盤の強度、地震による影響
 - ② 作業速度に応じた動荷重および台風または強風による影響等
- 2 本機は水平に設置して、クレーン作業を行ってください。
- 3 作業半径は、クレーンの旋回中心から荷重の重心までの水平距離です。
- 4 メインブームの定格総荷重は油圧チルトジブを取り除いた状態の値です。
- 5 135/152トンを超える定格総荷重の場合は、追加ブーリーブロック/特殊吊装置が必要です。

油圧チルトジブ定格総荷重表

LTM 1220NX-2



13.3m-60m

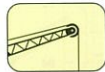

29m



360°



74t

メインブーム長さ ジブ長さ	13.3m 29m			43.4m 29m			47.7m 29m			52m 29m			56.3m 29m			60m 29m				
	角度	0°	22.5°	45°	0°	22.5°	45°	0°	22.5°	45°	0°	22.5°	45°	0°	22.5°	45°	0°	22.5°	45°	
作業半径(m)																				
5	8.6																			
6	8.6																			
7	8.6																			
8	8.6																			
9	8.5																			
10	8.4																			
11	8.2																			
12	8																			
14	7.6																			
16	7.1	5.9			6.9						6.1			5.4						
18	6.6	5.4			6.8						6.1			5.4						
20	6.1	5.1			6.6						5.9			5.3						
22	5.6	4.7			6.4						5.8			5.3						
24	5.2	4.4	3.7		6.2	5.1					5.7			5.2						
26	4.8	4.2	3.5		6	4.8					5.5	4.4		5.1						
28	4.4	3.9	3.4		5.7	4.5					5.4	4.3		5.1	4.1					
30	4	3.7	3.3		5.5	4.3					5.2	4.1		4.8						
32	3.7	3.5	3.1		5.3	4.2	3.3				5	4		4.7	3.9					
34	3.4	3.3	3.1		5.1	4	3.3				4.9	3.9		4.6	3.7					
36	3.1	3.2	3.1		4.9	3.9	3.3				4.7	3.8		4.4	3.6					
38	2.8	3.1			4.7	3.8	3.1				4.6	3.7		4.3	3.5					
40	2.6				4.5	3.6	3.1				4.4	3.5		4.2	3.4					
42					4.3	3.5	3.1				4.3	3.5		4.1	3.4					
44					4.2	3.4	3.1				4.1	3.4		4	3.3					
46					4	3.3	3.1				4	3.4		3.9	3.2					
48					3.9	3.3	3.1				3.9	3.3		3.8	3.2					
50					3.7	3.2	3.1				3.8	3.2		3.6	3.1					
52					3.6	3.1	3.1				3.6	3.1		3.6	3					
54					3.5	3	3.1				3.5	3		3.5	3					
56					3.3	3	3.1				3.4	3		3.4	3					
58					3.2	3	3.1				3.3	3		3.3	3					
60					3.1	2.9	3.1				3.3	2.9		3.3	2.9					
62					3	2.9	3.1				3.2	2.9		3.2	2.9					
64					2.9	2.9	3.1				3.1	2.9		3.1	2.9					
66					2.7	2.9	2.9				3	2.9		3	2.9					
68							2.8				2.9	2.8		2.9	2.8					
72											2.7	2.6		2.8	2.6					
76														2.7	2.6					
80														2.6	2.5					
84														2.5	2.4					
ブーム伸長率 (%)	I	0			46/0	0			92/46/0				92/46				92			100
	II	0			92/46				92/92/92				92/92				92			100
	III	0			92/92				92/92/92				92/92				92			100
	IV	0			46/92				46/92/92				46/92				92			100
	V	0			46/92				46/46/92				46/92				92			100

TAB 151312/151319/151326



13.3m-60m

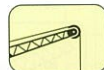

36m



360°



74t

メインブーム長さ ジブ長さ	13.3m 36m			43.4m 36m			47.7m 36m			52m 36m			56.3m 36m			60m 36m				
	角度	0°	22.5°	45°	0°	22.5°	45°	0°	22.5°	45°	0°	22.5°	45°	0°	22.5°	45°	0°	22.5°	45°	
7	6.3																			
8	6.3																			
9	6.2																			
10	6.2																			
11	6.1																			
12	6																			
14	5.7				5.1															
16	5.3				5															
18	5				4.9															
20	4.6	3.8			4.8															
22	4.3	3.5			4.6															
24	3.9	3.3			4.4															
26	3.6	3.3			4.3															
28	3.4	3.8			4.1															
30	3.1	2.6	2.2		3.9	3.1														
32	2.9	2.5	2.1		3.8	2.8														
34	2.6	2.3	2		3.6	2.7														
36	2.4	2.2	2		3.4	2.6														
38	2.2	2.1	1.9		3.3	2.5														
40	2	2	1.8		3.1	2.4	1.9													
42	1.9	1.9	1.8		3	2.3	1.9													
44	1.7	1.8	1.8		2.9	2.2	1.8													
46	1.6	1.6	1.8		2.7	2.1	1.8													
48					2.6	2.1	1.8													
50					2.5	2	1.8													
52					2.4	2	1.8													
54					2.3	1.9	1.7													
56					2.2	1.9	1.7													
58					2.1	1.8	1.7													
60					2.1	1.8	1.7													
62					2	1.8	1.7													
64					1.9	1.7	1.7													
66					1.9	1.7	1.7													
68					1.8	1.7	1.7													
72					1.8	1.7	1.7													
76					1.7	1.7														
80																				
84																				
ブーム伸長率 (%)	I	0			46/0	0			92/46/0				92/46				92			100
	II	0			92/46				92/92/92				92/92				92			100
	III	0			92/92				92/92/92				92/92				92			100
	IV	0			46/92				46/92/92				46/92				92			100
	V	0			46/92				46/46/92				46/92				92			100

TAB 151312/151319/151326

油圧チルトジブ (ブームエクステンション付) 定格総荷重表 LTM 1220NX-2

ジブ長さ 12.2m

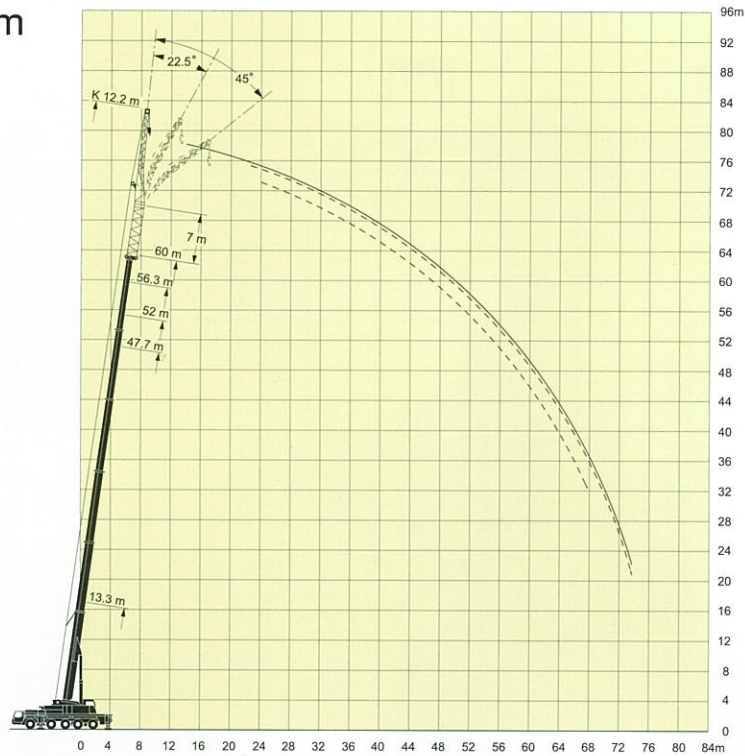

ジブ長さ 19.2m

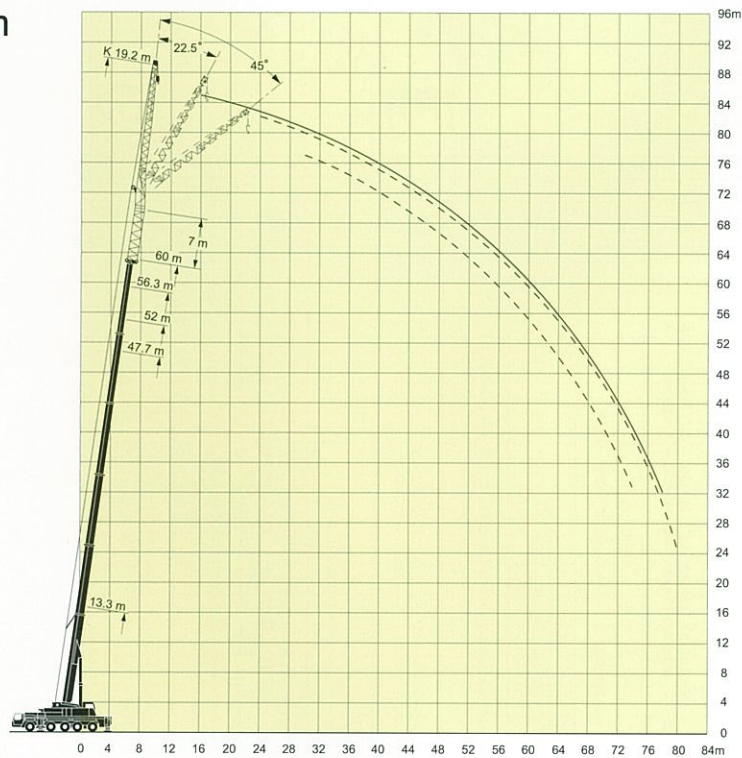

注意

- 1 定格総荷重はフックブロック、玉掛ワイヤー等の自重を含みます。
また、下記の条件が考慮されていませんのでクレーンの操作には充分気をつけてください。
 - ① 地盤の強度、地震による影響
 - ② 作業速度に応じた動荷重および台風または強風による影響等
- 2 本機は水平に設置して、クレーン作業を行ってください。
- 3 作業半径は、クレーンの旋回中心から荷重の重心までの水平距離です。
- 4 メインブームの定格総荷重は油圧チルトジブを取り除いた状態の値です。
- 5 135/152トンを超える定格総荷重の場合は、追加ブーリーブロック/特殊吊装置が必要です。

油圧チルトジブ (ブームエクステンション付) 定格総荷重表 LTM 1220NX-2

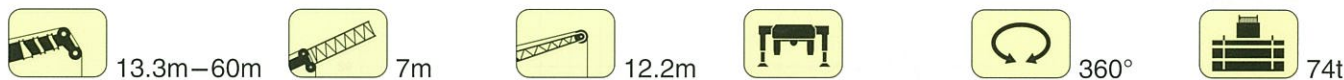

メインブーム長さ ジブ長さ	13.3m+7m			47.7m+7m			52m+7m			56.3m+7m			60m+7m		
	12.2m			12.2m			12.2m			12.2m			12.2m		
角度	0°	22.5°	45°	0°	22.5°	45°	0°	22.5°	45°	0°	22.5°	45°	0°	22.5°	45°
作業半径(m)															
3.5	21														
4	21														
4.5	21														
5	21														
6	21														
7	21														
8	21	19													
9	21	17.8													
10	20.5	16.8													
11	19.1	16	11.7	12.5											
12	17.9	15.1	11.7	12.5				11.6							
14	15.9	13.8	11.7	12.5				11.6							
16	14.2	12.7	11.1	12.5				11.6							
18	12.7	11.7	10.7	12.3				10.2							
20	11.5	10.8	10.3	11.9	10.9			10.1							
22	10.5	9.9	9.8	11.4	10.2	9.4		9.9	8.8						
24	9.6	9.1	9.3	10.9	9.8	9.1	10.6	9.6	8.7	9.2	9.1				
26	8.7	8.4	8.6	10.3	9.4	8.8	10.2	9.2	8.4	9.1	8.9	8.3			
28	7.9	7.8	7.6	9.8	9	8.5	9.7	8.9	8.1	8.8	8.6	7.7			
30		7.3		9.2	8.6	8.2	9.2	8.6	7.9	8.5	8.3	7.5			
32				8.7	8.2	7.9	8.8	8.2	7.6	8.2	8	7.3			
34				8.2	7.8	7.7	8.3	7.9	7.4	7.9	7.7	7.1			
36				7.8	7.5	7.4	7.9	7.5	7.2	7.6	7.4	6.9			
38				7.3	7.1	7.1	7.5	7.2	7	7.3	7.1	6.7			
40				6.9	6.8	6.8	7.1	6.9	6.5	6.7	6.9	6.5			
42				6.5	6.5	6.5	6.8	6.6	6.5	6.7	6.9	6.5			
44				6.1	6.2	6.2	6.4	6.3	6.3	6.4	6.6	6.3			
46				5.8	5.8	5.9	6.1	6	6.1	6.1	6.1	6.1			
48				5.5	5.5	5.6	5.8	5.7	5.8	5.8	5.8	5.8			
50				5.2	5.2	5.3	5.4	5.5	5.5	5.6	5.6	5.6			
52				4.9	4.9	5	5.2	5.2	5.3	5.3	5.3	5.4			
54				4.6	4.7	4.7	4.9	5	5	5	5.1	5.2			
56				4.3	4.4	4.4	4.7	4.7	4.8	4.8	4.9	4.9			
58				4.1	4.1	4.1	4.4	4.5	4.5	4.4	4.6	4.7			
60				3.8	3.9	3.9	4.2	4.3	4.3	3.9	4.2	4.3			
62				3.6	3.6	3.6	4	4	4	3.5	3.8	3.8			
64							3.7	3.8	3.8	3.2	3.4	3.4			
66							3.3	3.5	3.5	2.8	3	3			
68										2.5	2.6	2.6			
70										2.2	2.3	2.3			
72													2.1		
74													1.8		
76													1.5		
78														1.1	
80														1	
ブーム伸長率 (%)	I	0			0			46			92			100	
	II	0			92			92			92			100	
	III	0			92			92			92			100	
	IV	0			92			92			92			100	
	V	0			92			92			92			100	

TAB 151333/151340/151347

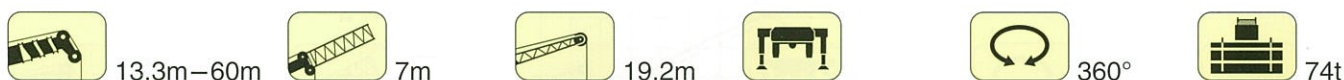

メインブーム長さ ジブ長さ	13.3m+7m			47.7m+7m			52m+7m			56.3m+7m			60m+7m		
	19.2m			19.2m			19.2m			19.2m			19.2m		
角度	0°	22.5°	45°	0°	22.5°	45°	0°	22.5°	45°	0°	22.5°	45°	0°	22.5°	45°
作業半径(m)															
4.5	18.6														
5	18.6														
6	18.3														
7	18														
8	17.5														
9	16.6														
10	15.8														
11	15														
12	14.2	11.8		8.4						7					
14	12.8	10.9		8.4				7.7							
16	11.5	10.1		8.4				7.7							
18	10.4	9.3	8.1	8.4				7.7							
20	9.4	8.5	7.8	8.4				7.7							
22	8.6	7.8	7.4	8.2	7.4			7.6	6.9						
24	7.7	7.1	7.1	7.9	7.2			7.5	6.8						
26	7.1	6.6	6.6	7.7	6.9	6.2		7.3	6.7						
28	6.5	6.1	6.2	7.5	6.7	6.1		7.2	6.5	5.8					
30	6	5.7	5.9	7.2	6.5	6		7	6.3	5.7					
32	5.5	5.3	5.5	7	6.3	5.8	6.8	6.1	5.6	6.5	5.9				
34	5.1	5	5.3	6.7	6.1	5.7	6.6	5.9	5.6	6.3	5.7	5.5			
36	4.7	4.7		6.5	5.9	5.5	6.4	5.8	5.4	6.1	5.6	5.4			
38				6.2	5.7	5.4	6.1	5.6	5.3	5.9	5.4	5.2			
40				5.9	5.5	5.3	5.9	5.4	5.2	5.8	5.3	5.1			
42				5.7	5.3	5.2	5.7	5.3	5.1	5.6	5.2	5			
44				5.4	5.2	5	5.4	5.1	5.1	5.4	5.1	4.9			
46				5.1	5	4.9	5.2	5	4.9	5.2	4.9	4.8			
48				4.9	4.8	4.8	5	4.9	4.8	4.8	4.7	4.7			
50				4.6	4.6	4.6	4.8	4.7	4.7	4.8	4.6	4.6			
52				4.4	4.4	4.5	4.6	4.5	4.6	4.6	4.5	4.5			
54				4.2	4.2	4.3	4.3	4.3	4.4	4.4	4.4	4.4			
56				3.9	4	4.1	4.1	4.2	4.2	4.2	4.2	4.2			
58				3.7	3.8	3.9	3.9	4	4.1	4	4	4.1			
60				3.5	3.6	3.6	3.7	3.8	3.9	3.8	3.9	3.9			
62				3.3	3.4	3.4	3.5	3.6	3.7	3.7	3.7	3.8			
64				3.1	3.2	3.2	3.3	3.4	3.5	3.3	3.5	3.6			
66				2.9	3	3	3.2	3.2	3.3	3.2	3.3	3.4			
68				2.7	2.8		3.1	3.1	3.1	3.2	3.2	3.3			
70							2.9	2.9	3	2.6	2.9	2.9			
72							2.6	2.7		2.4	2.6	2.6			
74										2.1	2.3	2.3			
76										1.8	2	2			
78										1.5	1.7	1.7			
80													1.1		
ブーム伸長率 (%)	I	0			0			46			92			100	
	II	0			92			92			92			100	
	III	0			92			92			92			100	
	IV	0			92			92			92			100	
	V	0			92			92			92			100	

TAB 151333/151340/151347

油圧チルトジブ (ブームエクステンション付) 定格総荷重表 LTM 1220NX-2

ジブ長さ22m

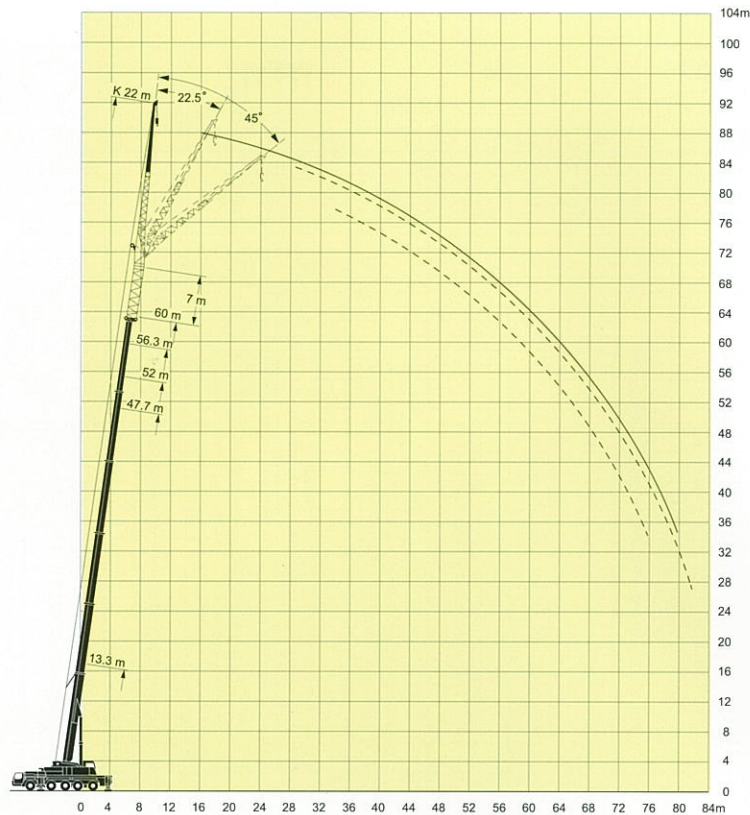

ジブ長さ26.2m

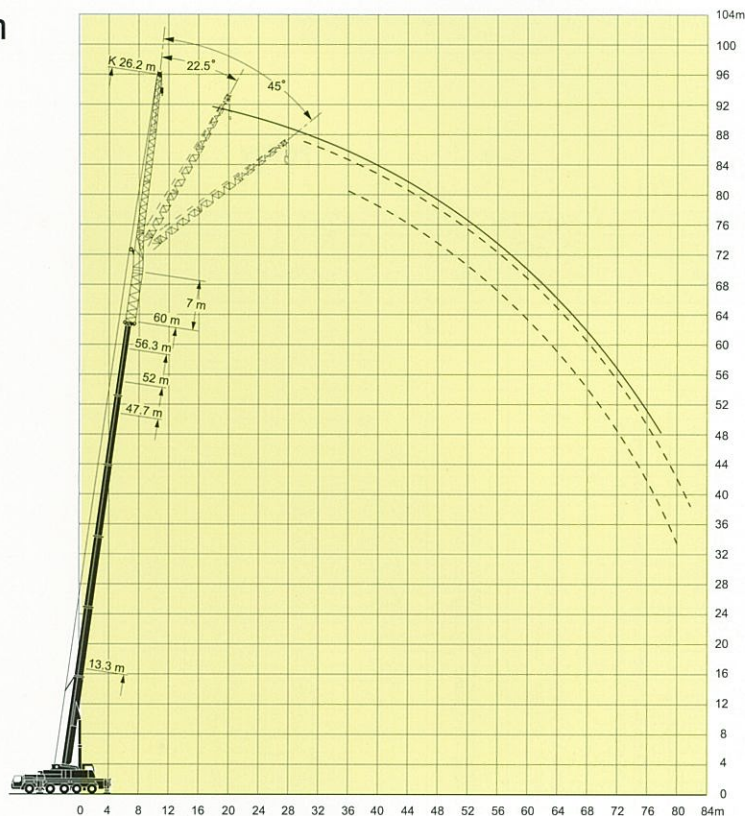

注意

- 1 定格総荷重はフックブロック、玉掛ワイヤー等の自重を含みます。
また、下記の条件が考慮されていませんのでクレーンの操作には充分気をつけてください。
 - ① 地盤の強度、地震による影響
 - ② 作業速度に応じた動荷重および台風または強風による影響等
- 2 本機は水平に設置して、クレーン作業を行ってください。
- 3 作業半径は、クレーンの旋回中心から荷重の重心までの水平距離です。
- 4 メインブームの定格総荷重は油圧チルトジブを取り除いた状態の値です。
- 5 135/152トンを超える定格総荷重の場合は、追加ブーリーブロック/特殊吊装置が必要です。

油圧チルトジブ (ブームエクステンション付) 定格総荷重表 LTM 1220NX・2



13.3m-60m

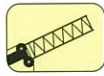

7m

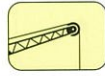

22m



360°



74t

メインブーム長さ ジブ長さ	13.3m+7m			47.7m+7m			52m+7m			56.3m+7m			60m+7m		
	22m			22m			22m			22m			22m		
角度	0°	22.5°	45°	0°	22.5°	45°	0°	22.5°	45°	0°	22.5°	45°	0°	22.5°	45°
作業半径(m)															
4.5	10.6														
5	10.6														
6	10.6														
7	10.6														
8	10.5														
9	10.3														
10	10.2														
11	10														
12	9.8				6.7										
14	9.4				6.7			6.2							
16	9				6.7			6.2		5.7				5.1	
18	8.6				6.7			6.2		5.7				5.1	
20	8.1				6.6			6.2		5.7				5.1	
22	7.7			5.9	6.5			6.2		5.7				5.1	
24	7.2			5.7	6.4			6.1		5.7				5.1	
26	6.8			5.4	6.3			6		5.7				5.1	
28	6.3			5.3	6.2			5.9		5.6				5.1	
30	5.9			5.2	6.1			5.8		5.5				5.1	
32	5.4			5.1	5.9			5.7		5.4				5.1	
34	5.1			4.9	5.8			5.5		5				5.1	
36	4.7			4.7	5.6			5.2		4.9				5.1	
38	4.4			4.3	5.5			5.1		4.8				5.1	
40				4.1	5.4			5		4.7				5.1	
42				4	5.3			4.9		4.6				5.1	
44				3.9	5.2			4.8		4.5				5.1	
46				3.8	5.1			4.7		4.4				5.1	
48				3.7	5			4.6		4.3				5.1	
50				3.6	4.9			4.5		4.2				5.1	
52				3.5	4.8			4.4		4.1				5.1	
54				3.4	4.7			4.3		4				5.1	
56				3.3	4.6			4.2		3.9				5.1	
58				3.2	4.5			4.1		3.8				5.1	
60				3.1	4.4			4		3.7				5.1	
62				3	4.3			3.9		3.6				5.1	
64				2.9	4.2			3.8		3.5				5.1	
66				2.8	4.1			3.7		3.4				5.1	
68				2.7	4			3.6		3.3				5.1	
70				2.6	3.9			3.5		3.2				5.1	
72				2.5	3.8			3.4		3.1				5.1	
74				2.4	3.7			3.3		3				5.1	
76					3.6			3.2		2.9				5.1	
78					3.5			3.1		2.8				5.1	
80					3.4			3		2.7				5.1	
82					3.3			2.9		2.6				5.1	
ブーム伸長率 (%)	I	0			0			46		92				100	
	II	0			92			92		92				100	
	III	0			92			92		92				100	
	IV	0			92			92		92				100	
	V	0			92			92		92				100	

TAB 151333/151340/151347



13.3m-60m

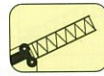

7m

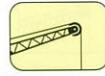

26.2m



360°



74t

メインブーム長さ ジブ長さ	13.3m+7m			47.7m+7m			52m+7m			56.3m+7m			60m+7m		
	26.2m			26.2m			26.2m			26.2m			26.2m		
角度	0°	22.5°	45°	0°	22.5°	45°	0°	22.5°	45°	0°	22.5°	45°	0°	22.5°	45°
作業半径(m)															
6	11.8														
7	11.8														
8	11.6														
9	11.5														
10	11.2														
11	10.8														
12	10.4														
14	9.7				5.9										
16	8.9				5.9			5.4							
18	8.2				5.9			5.4						4.3	
20	7.6				5.9			5.4						4.3	
22	6.9				5.9			5.4						4.3	
24	6.4				5.7			5.4						4.3	
26	5.9			4.4	5.6			5.3						4.3	
28	5.4			4.2	5.4			5.2						4.3	
30	4.9			4.1	5.3			5.1						4.3	
32	4.6			3.9	5.1			5						4.3	
34	4.2			3.8	4.9			4.8						4.3	
36	3.9			3.7	4.7			4.6						4.3	
38	3.6			3.6	4.5			4.4						4.3	
40	3.4			3.5	4.4			4.3						4.3	
42	3.1			3.5	4.3			4.2						4.3	
44	2.9			3.2	4.2			4.1						4.3	
46				3	4.1			4						4.3	
48				2.9	4			3.9						4.3	
50				2.8	3.9			3.8						4.3	
52				2.7	3.8			3.7						4.3	
54				2.6	3.7			3.6						4.3	
56				2.5	3.6			3.5						4.3	
58				2.4	3.5			3.4						4.3	
60				2.3	3.4			3.3						4.3	
62				2.2	3.3			3.2						4.3	
64				2.1	3.2			3.1						4.3	
66				2	3.1			3						4.3	
68				1.9	3			2.9						4.3	
70				1.8	2.9			2.8						4.3	
72					2.8			2.7						4.3	
74					2.7			2.6						4.3	
76					2.6			2.5						4.3	
78					2.5			2.4						4.3	
80					2.4			2.3						4.3	
82					2.3			2.2						4.3	
ブーム伸長率 (%)	I	0			0			46		92				100	
	II	0			92			92		92				100	
	III	0			92			92		92				100	
	IV	0			92			92		92				100	
	V	0			92			92		92				100	

TAB 151333/151340/151347

油圧チルトジブ (ブームエクステンション付) 定格総荷重表 LTM 1220NX-2

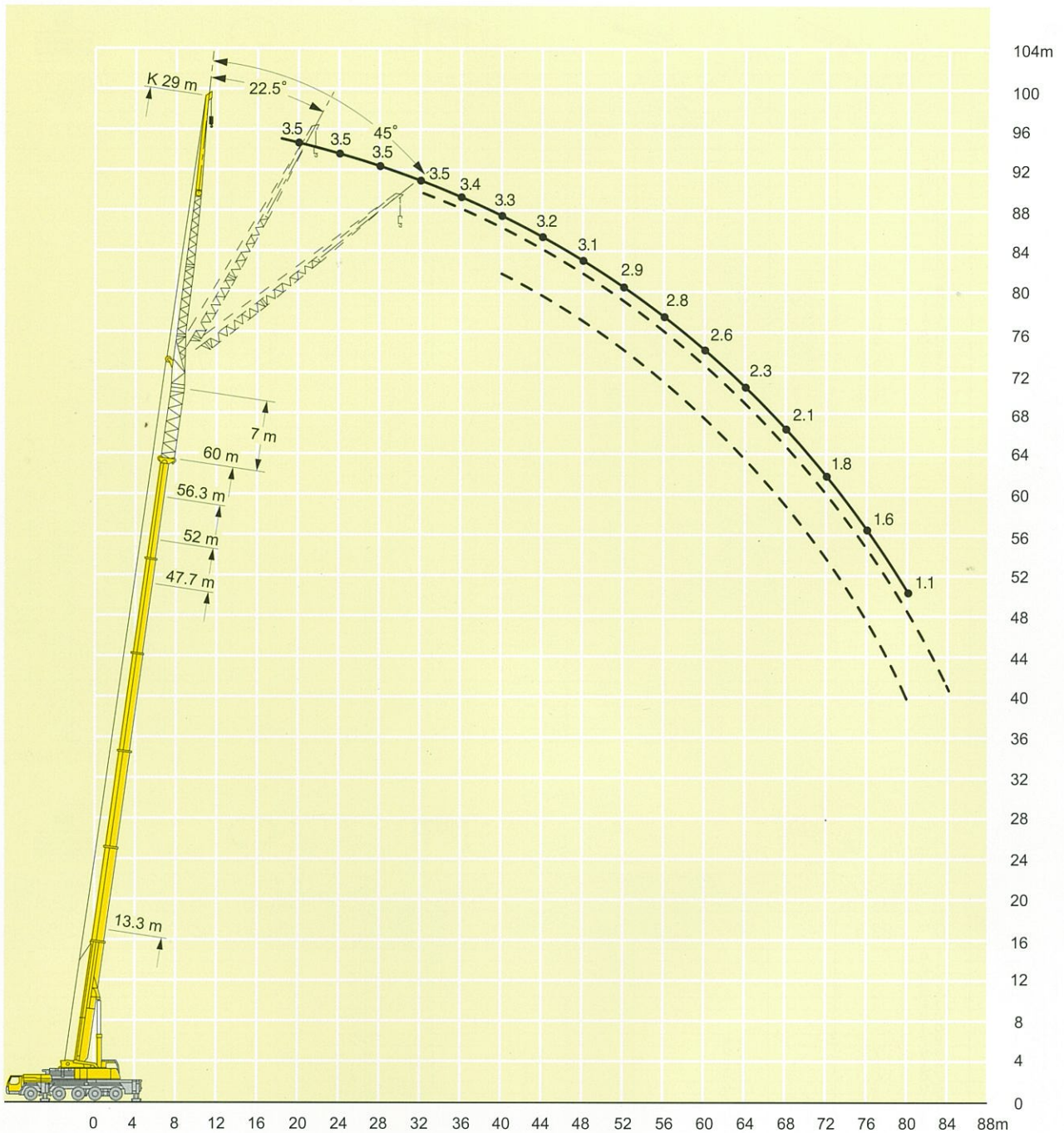

注意

- 1 定格総荷重はフックブロック、玉掛ワイヤー等の自重を含みます。
また、下記の条件が考慮されていないのでクレーンの操作には充分気をつけてください。
 - ① 地盤の強度、地震による影響
 - ② 作業速度に応じた動荷重および台風または強風による影響等
- 2 本機は水平に設置して、クレーン作業を行ってください。
- 3 作業半径は、クレーンの旋回中心から荷重の重心までの水平距離です。
- 4 メインブームの定格総荷重は油圧チルトジブを取り除いた状態の値です。
- 5 135/152トンを超える定格総荷重の場合は、追加ブーリーブロック/特殊吊装置が必要です。

油圧チルトジブ (ブームエクステンション付) 定格総荷重表 LTM 1220NX-2

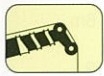

13.3m-60m

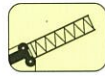

7m

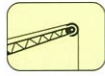

29m



360°



74t

メインブーム長さ ジブ長さ	13.3m+7m			47.7m+7m			52m+7m			56.3m+7m			60m+7m		
	29m			29m			29m			29m			29m		
角度	0°	22.5°	45°	0°	22.5°	45°	0°	22.5°	45°	0°	22.5°	45°	0°	22.5°	45°
作業半径(m)															
6	7.8														
7	7.8														
8	7.8														
9	7.8														
10	7.8														
11	7.8														
12	7.7														
14	7.5				4.8										
16	7.2				4.8			4.4			4.1				
18	6.8	5.7			4.8			4.4			4.1			3.5	
20	6.5	5.4			4.8			4.4			4.1			3.5	
22	6.1	5			4.8			4.4			4.1			3.5	
24	5.7	4.8			4.8			4.4			4.1			3.5	
26	5.4	4.5	3.6		4.7			4.4			4.1			3.5	
28	5.1	4.3	3.5		4.6			4.4			4.1			3.5	
30	4.7	4	3.4		4.6			4.4			4.1			3.5	
32	4.4	3.8	3.3		4.4	3.9		4.4			4.1			3.5	
34	4.2	3.7	3.2		4.3	3.7		4.3			4			3.5	3.2
36	3.9	3.5	3.1		4.2	3.6		4.2			3.9			3.5	3.2
38	3.6	3.4	3.1		4.1	3.5	3	4			3.8			3.3	3.2
40	3.4	3.2	3.1		3.9	3.4	3	3.8			3.7			3.3	3.2
42	3.1	3.1	3.1		3.8	3.4	3	3.7			3.6			3.3	3.2
44	2.9	2.9			3.7	3.3	3	3.6			3.5			3.3	3.2
46	2.7	2.7			3.6	3.2	3	3.5			3.4			3.3	3.2
48					3.5	3.1	3	3.4			3.3			3.3	3.2
50					3.5	3.1	3	3.4			3.3			3.3	3.2
52					3.3	3	3	3.2			3.2			3.3	3.2
54					3.1	2.9	3	3.1			3.1			3.3	3.2
56					3	2.8	3	3			3.1			3.3	3.2
58					2.9	2.7	3	2.9			3			3.3	3.2
60					2.8	2.7	3	2.8			3			3.3	3.2
62					2.7	2.6	3	2.7			3			3.3	3.2
64					2.6	2.5	3	2.6			3			3.3	3.2
66					2.4	2.4	3	2.5			3			3.3	3.2
68					2.3	2.3	3	2.4			3			3.3	3.2
70					2.3	2.3	3	2.4			3			3.3	3.2
72					2.2	2.2	3	2.3			3			3.3	3.2
74					2.1	2.1	3	2.2			3			3.3	3.2
76					1.8	1.9	3	2.1			3			3.3	3.2
78					1.7	1.8	3	2			3			3.3	3.2
80							3	1.9			3			3.3	3.2
82							3	1.8			3			3.3	3.2
84							3	1.6			3			3.3	3.2
88							3	1.1			3			3.3	3.2
ブーム伸長率 (%)	I	0			0			46			92			100	
	II	0			92			92			92			100	
	III	0			92			92			92			100	
	IV	0			92			92			92			100	
	V	0			92			92			92			100	

TAB 151333/151340/151347



13.3m-60m



7m

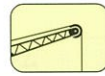

36m



360°



74t

メインブーム長さ ジブ長さ	13.3m+7m			47.7m+7m			52m+7m			56.3m+7m			60m+7m		
	36m			36m			36m			36m			36m		
角度	0°	22.5°	45°	0°	22.5°	45°	0°	22.5°	45°	0°	22.5°	45°	0°	22.5°	45°
作業半径(m)															
7	5.7														
8	5.7														
9	5.7														
11	5.7														
12	5.7														
14	5.6														
16	5.4				3.4			3							
18	5.1				3.4			3			2.6				
20	4.8				3.4			3			2.6				
22	4.5	3.6			3.4			3			2.6			2.1	
24	4.3	3.4			3.4			3			2.6			2.1	
26	4	3.2			3.3			3			2.6			2.1	
28	3.7	3			3.3			3			2.6			2.1	
30	3.5	2.8			3.2			3			2.6			2.1	
32	3.3	2.7			3.1	2.4		3			2.6			2.1	
34	3	2.5	2.2		3	2.4		3			2.6			2.1	
36	2.8	2.4	2.1		2.9	2.3		2.9			2.6	2.1		2.1	1.9
38	2.7	2.3	2		2.8	2.3		2.7			2.6	2.1		2.1	1.9
40	2.5	2.2	1.9		2.7	2.2		2.6			2.6	2.1		2.1	1.9
42	2.3	2.1	1.9		2.6	2.2		2.5			2.6	2.1		2.1	1.9
44	2.2	2	1.8		2.5	2.1		2.4			2.5	2.1		2.1	1.9
46	2	1.9	1.8		2.5	2.1		2.4	1.7		2.4	2.1		2.1	1.9
48	1.9	1.9	1.8		2.4	2		2.3	1.7		2.3	2.1		2.1	1.9
50	1.8	1.8	1.8		2.3	2		2.2	1.7		2.3	2.1		2.1	1.9
52	1.7	1.8			2.3	1.9		2.2	1.7		2.2	2.1		2.1	1.9
54					2.1	1.9		2.1	1.7		2.1	1.8		2	1.8
56					2.1	1.8		2.1	1.6		2.1	1.8		2	1.7
58					2	1.8		2	1.6		2	1.8		1.9	1.7
60					2	1.8		2	1.6		2	1.8		1.9	1.7
62					1.9	1.7		1.9	1.6		1.9	1.7		1.8	1.6
64					1.9	1.7		1.9	1.6		1.9	1.7		1.8	1.6
66					1.8	1.7		1.8	1.6		1.8	1.6		1.7	1.6
68					1.8	1.7		1.8	1.6		1.8	1.6		1.7	1.6
70					1.7	1.6		1.7	1.6		1.8	1.6		1.6	1.5
72					1.7	1.6		1.7	1.6		1.7	1.6		1.6	1.5
74					1.6	1.6		1.6	1.6		1.7	1.6		1.5	1.5
76					1.6	1.6		1.6	1.6		1.6	1.5		1.5	1.5
78					1.5	1.5		1.5	1.6		1.6	1.5		1.5	1.5
80					1.4	1.5		1.5	1.6		1.5	1.5		1.5	1.5
82					1.3	1.4		1.4	1.5		1.3	1.5		1.5	1.5
84					1.2			1.3	1.4		1	1.3		1	1.3
86								1.2	1.3			1.1			1.1
88								1	1.3			1.1			1
ブーム伸長率 (%)	I	0			0			46			92			100	
	II	0			92			92			92			100	
	III	0			92			92			92			100	
	IV	0			92			92			92			100	
	V	0			92			92			92			100	

TAB 151333/151340/151347

油圧チルトジブ (ブームエクステンション付) 定格総荷重表 LTM 1220NX-2

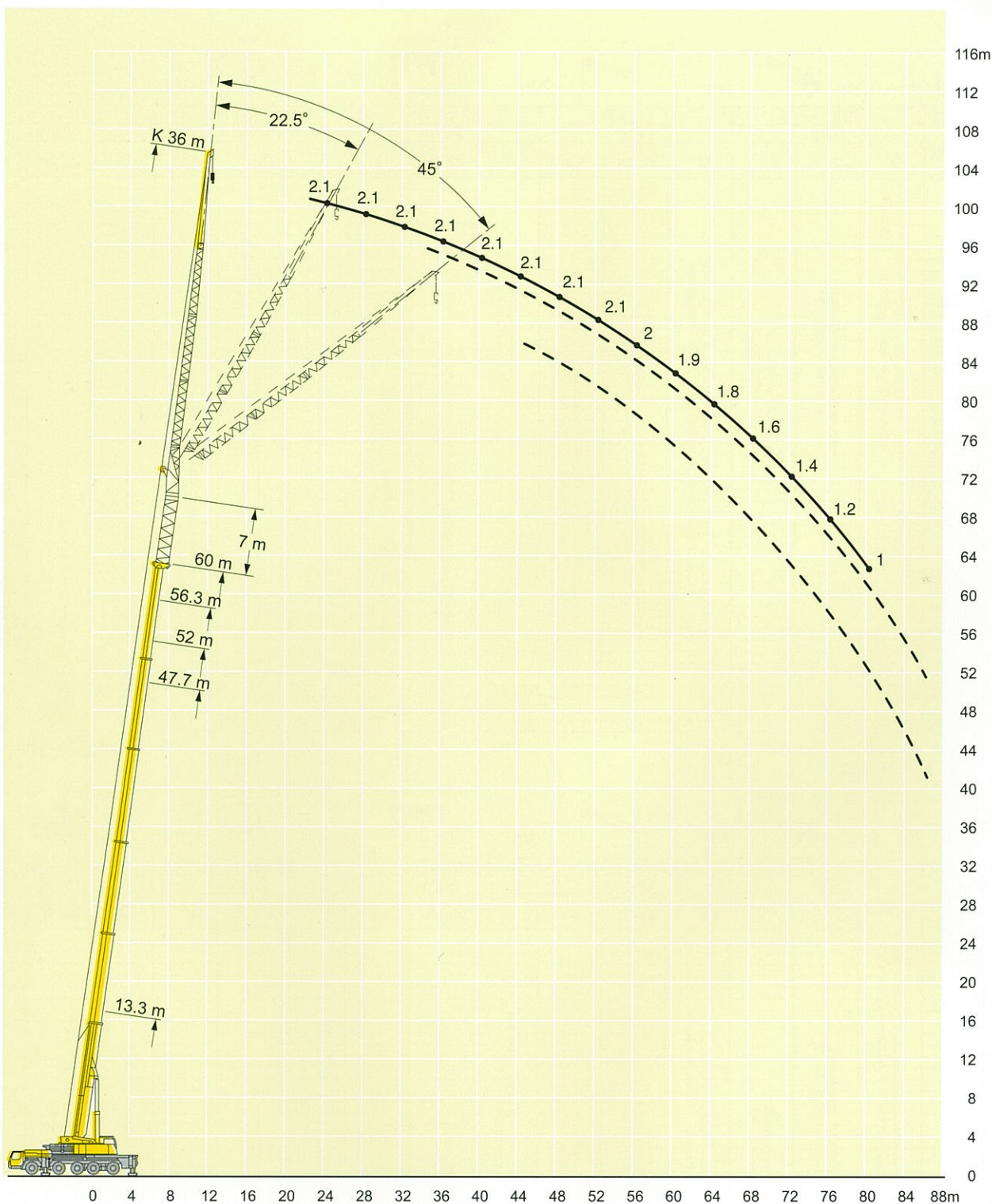

注意

- 1 定格総荷重はフックブロック、玉掛ワイヤー等の自重を含みます。
また、下記の条件が考慮されていませんのでクレーンの操作には充分気をつけてください。
 - ① 地盤の強度、地震による影響
 - ② 作業速度に応じた動荷重および台風または強風による影響等
- 2 本機は水平に設置して、クレーン作業を行ってください。
- 3 作業半径は、クレーンの旋回中心から荷重の重心までの水平距離です。
- 4 メインブームの定格総荷重は油圧チルトジブを取り除いた状態の値です。
- 5 135/152トンを超える定格総荷重の場合は、追加ブーリーブロック/特殊吊装置が必要です。

カウンターウエイト

単位：mm

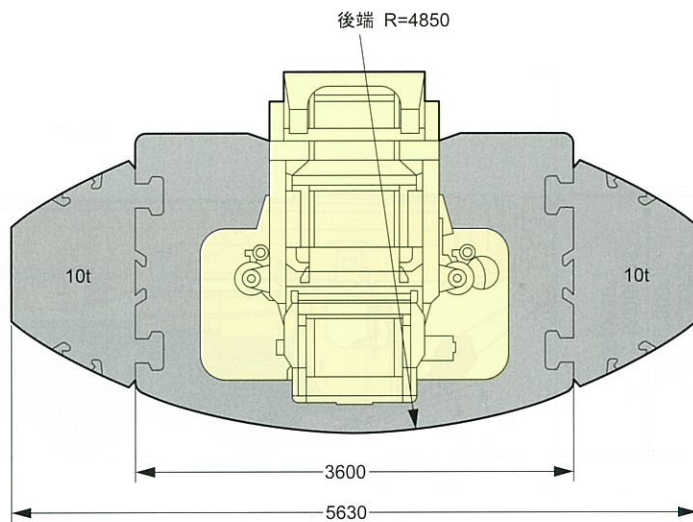
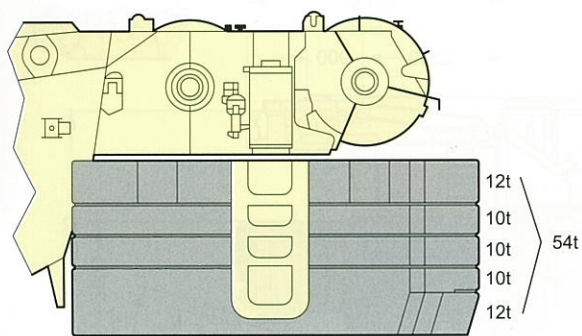

走行軌跡図 (リアステアリング操作時)

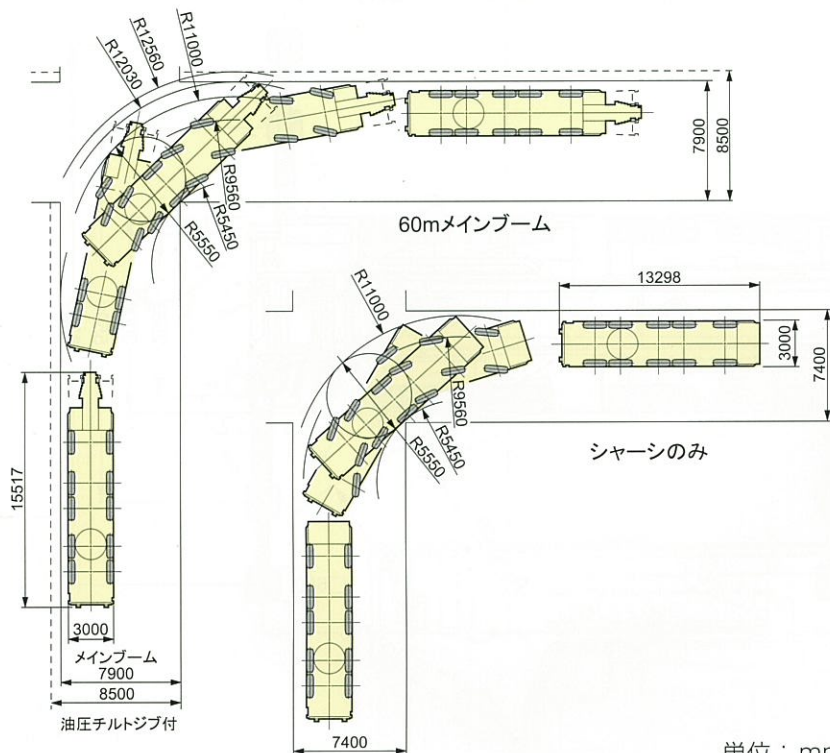

単位：mm

駆動部

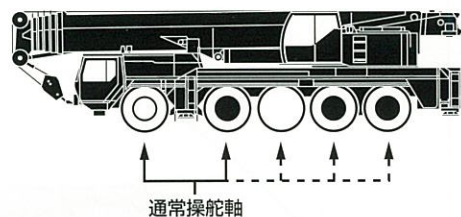

※第3、4、5軸は、第1、2軸と独立して操舵可能。(リアステアリング操作)
 30km/h以下：1、2軸及び、3、4、5軸が電氣的に操舵。
 30km/h以上：3、4軸が直進に固定。
 60km/h以上：さらに5軸が直進に固定。
 ただし、状況により1、2、3軸が同方向、4、5軸が反対方向に操舵も可能。

- 駆動軸：常時駆動します。
- 駆動軸：ラフロード走行時に前輪駆動として使用します。(オプション設定)

本機は、公道を走行する場合、メインブームおよびカウンターウエイトをはずし、走行しなければなりません。

主寸法

LTM 1220NX-2

外観寸法

単位：mm

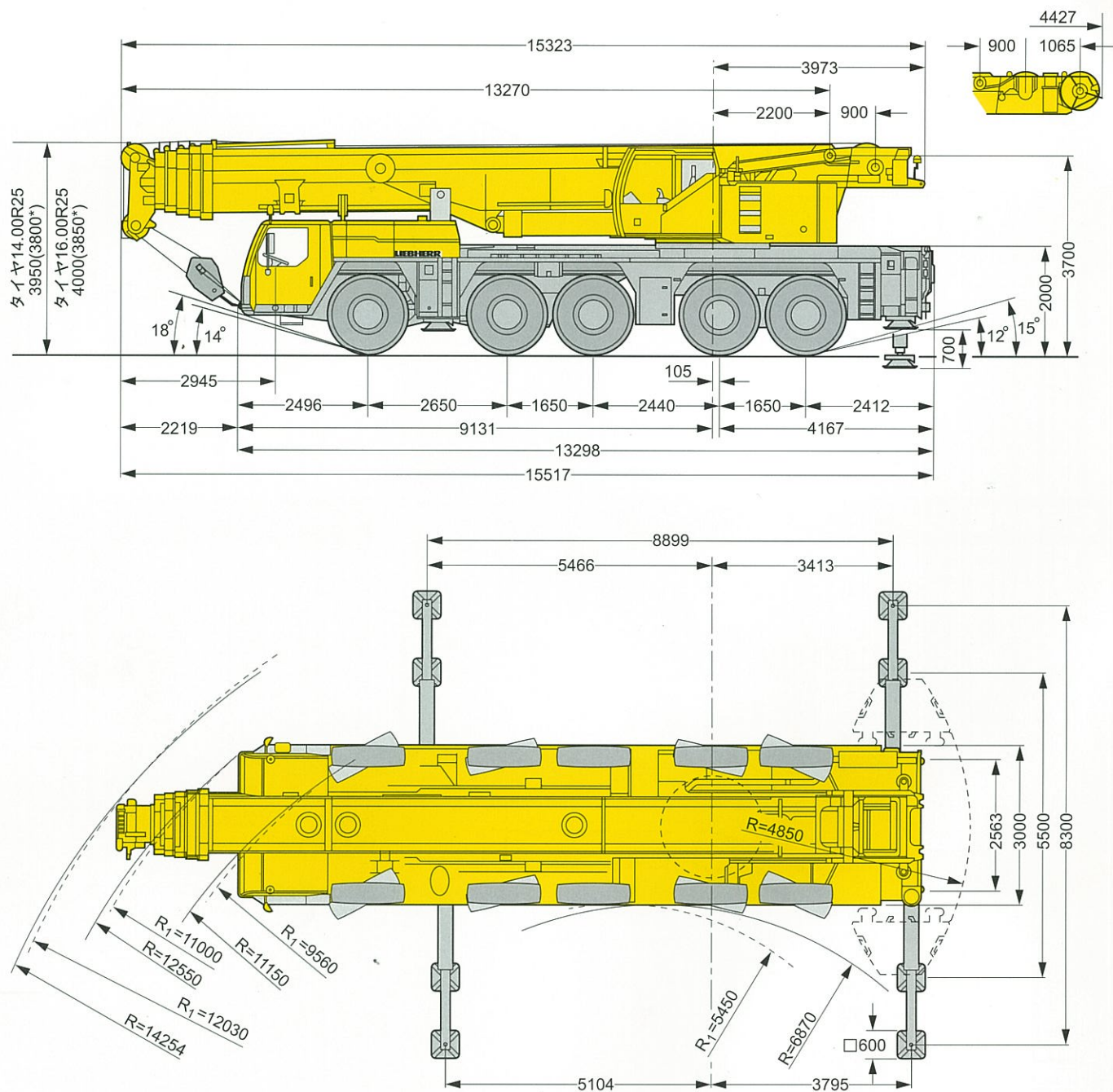

*サスペンションを150mm下げた状態
R1 = 全輪ステアリング時

リープヘル・ジャパン株式会社

〒230-0053 横浜市鶴見区大黒町5番39号

TEL. 045-505-8687 (営業)

045-505-8689 (サービス)

FAX. 045-505-8683

なお、本仕様は予告なく変更することがあります。

TD 151.00.DEF05.2004-2
2015.07.1500